

Chapter 13

Artificial Intelligence Approaches for the COVID-19 Pandemic



Pilla Srinivas, Divya Midhun Chakkravarthy, and Debnath Battacharyya

13.1 Introduction

Novel coronavirus (n-CoV) or COVID-19 is a new virus that originated from the coronavirus family in 2019. It is originated during the early December 2019 in the provinces of Hubei, near Wuhan city in China [1]. Phylogenetic analysis has reported that this virus's main carrier is obtained from bats where these bats and other kinds of animals are sold in the Huanan Seafood Market. Later on, it started spreading from those animals to humans [2]. It also spreads among humans during direct or indirect transmission through the droplets of the affected person. When the infected person sneezes or coughs or exhales, there is a chance of releasing the droplets. The virus is heavier in nature and so cannot be in the air for a longer time; it reaches the ground or to the surfaces. These contaminated surfaces act as the carriers of the virus. When the intermediate persons come into close contact with these contaminated areas and then touch their eyes, nose, and mouth, these intermediate persons act as the carriers, resulting in the spread of the virus knowingly or unknowingly. The spread rate of this novel coronavirus is also higher

P. Srinivas (✉)

Department of Computer Science and Engineering, Dadi Institute of Engineering & Technology, Anakapalle, India

D. M. Chakkravarthy

Department of Computer Science and Multimedia, Lincoln University College, Petaling Jaya, Malaysia

e-mail: midhun@lincoln.edu.my

D. Battacharyya

Department of Computer Science and Engineering, K L Deemed to be University, KLEF, Guntur, India

e-mail: debnathb@kluniversity.in

© Springer Nature Switzerland AG 2022

L. Garg et al. (eds.), *Healthcare Informatics for Fighting COVID-19 and Future Epidemics*, EAI/Springer Innovations in Communication and Computing,
https://doi.org/10.1007/978-3-030-72752-9_13

249

Fig. 13.1 Microscopic view of COVID-19

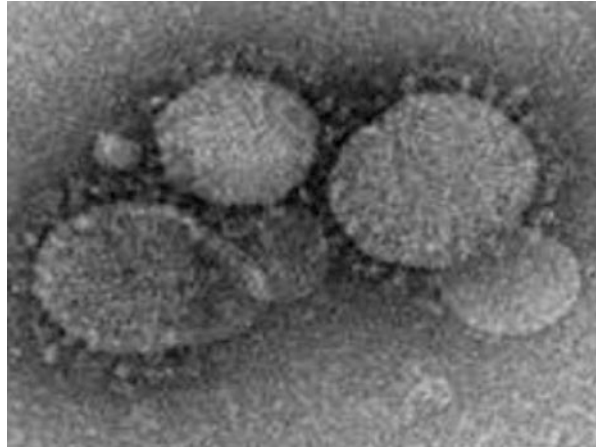

when compared to the other flus. The affected person experiences many symptoms, and among them, some of the main symptoms are high fever, dry cough, sore throat, and difficulty in breathing. The World Health Organization (WHO) has announced COVID-19 as a pandemic on March 11, 2020 [3].

The affected person may fall sick with a few of the symptoms. Some of the people experience mild to moderate symptoms like Middle East respiratory syndrome (MERS) and severe acute respiratory syndrome (SARS), and people act as carriers without any symptoms. COVID-19 is a highly infectious disease which has a main negative impact on respiratory tract infection. Generally, the virus has a particle size of 80–150 nm. The final stage of the severity of virus among the patients leads to difficulty in breathing, resulting in anaemia and finally leading to death. People with diabetes, respiratory tract infections, high blood pressure, cancer, and other diseases are at high risks and sometimes lead to death. Most people in the early stages and healthy persons with strong immunity recover from the virus without requiring hospital treatment. Early detection of this disease yields to early diagnosis. The person who is suffering from shortness of breath and chest pain needs to seek immediate medical attention. The conclusion of detecting the virus is also a time-consuming process, and sometimes the test results also furnish false results while testing the victims, increase in time results the number of cases day by day. (Fig. 13.1) [3].

Artificial intelligence (AI) is sometimes also realised as machine intelligence where machines demonstrate its intelligence rather than the human brains' natural intelligence. John McCarthy is the person who has first described the term artificial intelligence during 1956 when the computers are acting smarter in analysing and decision-making when compared to humans. AI plays a beneficial role in the field of healthcare systems in making smarter decisions compared to human intelligence. Artificial intelligence has practical purposes on dealing with clinical reports decision-making, assessment based on the clinical records, management of healthcare, and research on clinical records for better outcomes [4]. AI has proved its

applications in many real-time applications like weather forecasting, detecting faces, fraud detection, and its positive medical benefits. AI is also applied in analysing images in radiology and pathology and thereby producing successful benefits in fast diagnosing and delivering accurate reports. It is advantageous when dealing with big data which is impossible for humans to create datasets and analyse the data. Natural language processing techniques help in analysing based on the patients' medical records [5].

Most artificial intelligence techniques such as artificial neural networks, Bayesian networks, and Fuzzy expert systems are used in healthcare systems. The Artificial Intelligence investments took place during 2016 were in healthcare systems compared to the other areas. After Matching Artificial Intelligence with Medicine, it can be dichotomised into virtual and physical. Virtual can be defined in analysing the clinical records by applying techniques like artificial neural networks to make decisions and diagnose. The physical parts are performing robotics in surgeries and for the disabled people [6]. We will take the medical records of the patients from the medical centre and thereby apply some of the artificial intelligence approaches to define the actual condition of the patients and help in diagnosing. The datasets are designed based on the collected database, containing the data such as the patients' symptoms and their conditions. As these symptoms are common like flu, it is also difficult to identify and differentiate the patients of normal flu and victims of COVID-19. The symptoms may not be the same for all the patients, and different data is collected, analysed, and integrated. Some of the artificial intelligence approaches like natural language processing techniques help understand the clinical records of data obtained from the clinical database of COVID-19 patients and provide better results. Artificial neural networks are also applied to identify the chest X-rays of some of the patients, making correct decisions in identifying the severity of the patients based on the chest radiographs. It helps in consuming less time and provides accurate results in specifying the presence of disease.

13.2 Artificial Intelligence

13.2.1 How Artificial Intelligence Is Related to Machine Learning

Machine learning works on the concept of machines should be able to learn and redesign through experience. Artificial intelligence (AI) works on the principle of making machines learn and execute the tasks smartly. Artificial intelligence applies machine learning concepts and deep learning concepts. Artificial intelligence and machine learning are not the same. Machine learning helps in learning from behaviour, examples, and definitions, whereas artificial intelligence helps in learning and analysing, reasoning, and solving problems [7]. Machine learning implements

Fig. 13.2 Relation between artificial intelligence machine learning and deep learning

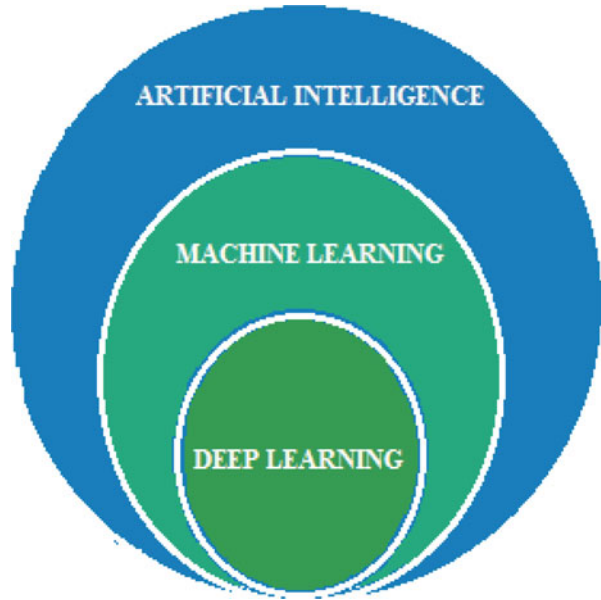

artificial building model. It makes use of neural networks, statistics, and research without implementing programming and learns from experience. In healthcare systems, AI provides better treatment efficiency which can be determined quickly. In case of online shopping, AI helps to add on items based on their purchase interest of items. In finance, AI helps to get rid of fraud instead of just detecting it. Artificial intelligence makes use of machine learning and deep learning concepts to solve problems. The relationship between artificial intelligence, machine learning, and deep learning can be explained in terms of deep learning which is a subset of machine learning. Machine learning is a subset of artificial intelligence (Fig. 13.2).

If we consider the algorithm's example, the math and the algorithm's logic imply machine learning, and math and the algorithm's code imply artificial intelligence. Artificial intelligence is incorporating human intelligence to machines. In AI, machines execute its tasks to solve the problems based upon some rules; this kind of intelligent behaviour is called AI. AI can be categorised into two categories: general and narrow. In general AI, machines can solve many problems and execute the tasks intelligently, whereas in narrow AI, machines can execute the task more intelligently than humans. In the case of machine learning, a lot of data is given to the machine, and the algorithm is trained based upon the given data. It learns how to make decisions while training the algorithm. Based on the data provided, it makes it easier for the machines to make accurate decisions. Machine learning is a simple procedure which helps in understanding AI.

AI and ML help in pattern recognition, advanced image processing in bioinformatics, medical imaging, and medical robotics [8].

13.2.2 Artificial Intelligence Techniques

AI technique is a method that should be represented so that the knowledge expresses generalisation where the properties need to be gathered and grouped together instead of taking them separately. In many AI domains, bulk data comes automatically for programming. The people must transfer the data to programs in an understandable form and in the program's format. The techniques can be easily modified to rectify errors and alter real-life condition changes [8]. The techniques can also be utilised even if it is incomplete and inaccurate, and it can be used in any kind of situations. There are many artificial intelligence techniques used in real-life applications. There are five major artificial intelligence techniques among numerous techniques: heuristics, support vector machines, artificial neural networks, Markov decision process, and natural language processing.

13.2.2.1 Heuristics

It is one of the best searching algorithms used in artificial intelligence. It solves problems to the solutions when compared to the other classic methods. It employs the technique of reducing the alternatives for the results. It is based on the concept of trial and error method; it learns from its mistakes. It is one of the best techniques used in AI, and it suits best for solving difficult problems. It is used to identify the best way among all the possible routes and the shortest route among different routes. In real-time applications, Google Maps [9] are used to mention the best shortest route from source to the destination. It is often used sometimes to calculate NP-complete problems and also decision problems. This algorithm may not find accurate results but finds the solution closer to the best one quickly and easily.

13.2.2.2 Support Vector Machine (SVM)

It is one of the best supervised machine learning algorithms used in classification problems and regression challenges. Artificial Intelligence deals with the classification problem it helps to classify among the based on some instances. The categories in email systems use vector machines to categorise the emails based on social, spam, and promotion. It is also used in detecting images, text recognition, and face recognition systems. Consider the graph in an n -dimensional space, n represents the number of features, and each coordinate represents different features. The points represented in the graph are data points. Vectors represent the coordinates of individual observation. By applying classification techniques, it separates the two classes based on their features (Fig. 13.3).

Fig. 13.3 Support vector machine classifier

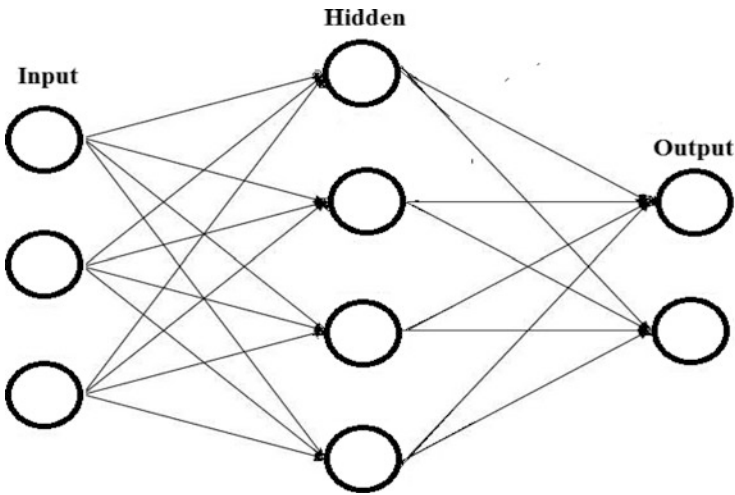
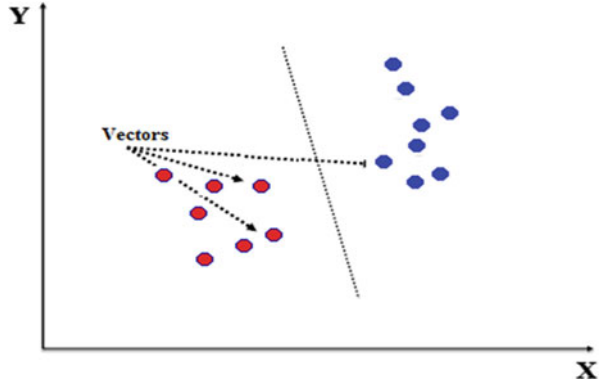

Fig. 13.4 Artificial neural networks

13.2.2.3 Artificial Neural Networks (ANN)

An artificial neural networks is a collection of interconnected nodes which resemble like neurons in a human brain. Each node represents an artificial neuron, and the connections represent the output of one neuron and input of another neuron. The outcome of each node is said to be node value. Each connection between the nodes has weights. If the network generates good outcomes, then there is no need to alter the weights (Fig. 13.4).

If the network generates bad outcomes, then the system alters its weights to generate the best results.

These weights control the signal between two neurons. Feedforward artificial neural network and feedback artificial neural networks are two types of artificial neural networks.

13.2.2.4 Markov Decision Processes (MDP)

It is used in modelling sequential decision problems and also reinforcement learning problems. Another advantage of the Markov decision process is optimised planning. Markov decision indicates to find the correct decision representing which decision results in which state. The MDP model consists of possible states, set of possible actions, transition probabilities, and rewards. Assume the scenario of Robot in which set of possible states represents the robots world, set of possible actions represents to the robot can take a right, left, front, back and transition probabilities represent robot moving from right to left and rewards represents. If the robot moves to the left to reach its destination where that is the actual destination, then that is the higher reward. It also has its advantages in solving stochastic, dynamic decisions to find optimal solutions [10].

13.2.2.5 Natural Language Processing (NLP)

It is used to deal with the interactions between human and computer languages. It allows computer how to program to process and to analyse a large amount of human language data. It is a technique used by the computer to understand, interpret, and manipulate the human language. It is also used in speech recognition. Markov decision is already in use by many multitude companies in real-life applications like Apple Siri, Microsoft Cortana, and Amazon Alexa. It also has its applications in parsing, text recognition, and part of speech. It is a technique from machine learning, and artificial intelligence reformats text for synthetic analysis. During text recognition, the text may be from medical prescription or medical records of the patient. NLP has provided successful medical decision-making results and tracking patient's records by identifying syndromes [11].

13.2.3 Artificial Neural Networks

Artificial neural networks takes multiple inputs and provide a single output. The computer code has several simple highly interconnected models meant for simulating and processing the information. It has one input and one output layer and at least one hidden layer. The main aim is to transfer from input to valuable output. Information flow happens between two ends in two ways, feedforward and feedback networks. The data flows only in one direction without having any loop from input to output in feedforward network. Feedforward is normally used in pattern recognition, and these may have zero or multiple hidden layers. In feedback network, data travels from input to output in both the directions with loops in the network. It can use its internal state to process a series of inputs (Fig. 13.5).

Neural networks make use of different algorithms to train neural networks. Feed-forward algorithm, sigmoid, cost function, backpropagation, and gradient descent

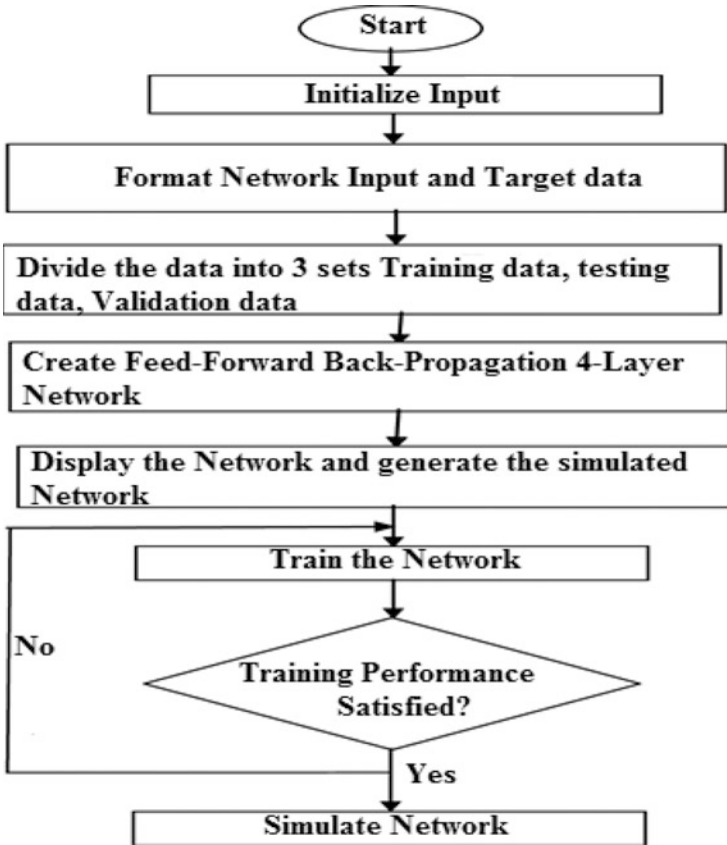

Fig. 13.5 Flowchart of artificial neural networks

are common algorithms used by neural networks. First, to start the algorithm, we need to assign the weights to all the links. Next, we need to find out the links of active hidden nodes by using the inputs and links. Next, we need to find the activation rate of output nodes and hidden nodes and link them to the output. Mean square errors found in the output node and to generate all the links between the output and hidden nodes. We need to pass these errors to hidden and output nodes using the errors at the output node. Generate the weights and repeat the process between the hidden and input nodes until the satisfactory criteria are met. The predicted value is output or the sum of all outputs of individual neurons in the output. Patterns of information are given to the network's input units, thereby travelling through hidden layers and finally obtained in output units.

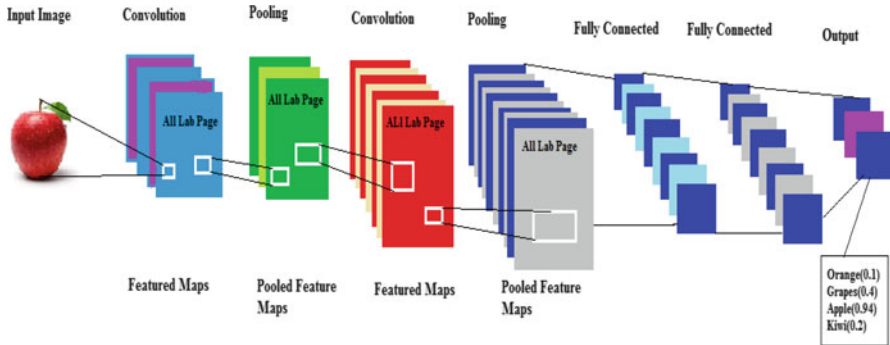

Fig. 13.6 Image processing of convolution neural network

13.2.3.1 Convolution Neural Network (CNN)

It belongs to the neural network class, which has proven its successful results in image recognition and image processing. This network has Multilayer Perceptron for processing and classification. It takes an image as inputs and puts weights and effectively differentiates images from one another. In artificial intelligence, it solves many solutions to real-life problems. It includes a special kind of operation called convolution. It is used in AI-based robots, virtual assistants, and self-driving cars. If we consider image processing, it scans the image to pass through the filter maps which are generated for each individual filter. We can add more and more filtering layers and feature maps to create deeper convolution neural network (CNN). CNN's real-life problems are image recognition, text recognition, gender recognition, and emotion recognition (Fig. 13.6).

It requires the models first to get trained and later tested. The input image is transferred through the series of Convolution layers using filters, pooling, fully connected layers and Softmax function is used to classify the object using the probabilities 0 or 1. Convolution and pooling layers act as extractors of the input image, and fully connected layers act as classifiers. The sum of all output layers is the convolution neural network comprise of some operations like convolution, nonlinearity, pooling, and classification. Many real-life business applications use convolution neural networks like Facebook automatic tagging algorithms, Google image search, and Amazon product recommendations. CNN has also proved its applications in healthcare systems like radiology [12].

Medical imaging also plays an important role in clinical care and diagnosing. CNN helps in medical image processing by using its methods. We have taken Chest X-rays CT scans for the best approach to diagnose the pneumonia. 50,000 patients die per year due to lack of classifying pneumonia from the normal Chest X-ray patients. Radiologists can identify which they were in lack in so regions because of rare and expensive resources. Normal classical methods like support vector machine (SVM) used in long years ago are time-consuming and vary according to different

objects. We need to increase efficiency by considering small datasets and increasing it on big datasets. CNN are widely used in transforming medical image classification techniques that have generated efficient results since 2012. CNN trained with 121 layers of dataset with 100,000 chest X-ray has the best performance compared with four radiologists' average performance [13].

13.2.4 Natural Language Processing (NLP)

NLP used in healthcare systems is increasing rapidly because of its ability to search, analyse, and interpret large amounts of patient's datasets. NLP in healthcare provides the best results while dealing with unstructured data and providing better patient results. There are many difficulties for the doctors to maintain the chart notes of patient's records, but with increasing, modern technology, data is maintained in electronic health record (EHR) systems. NLP is the main source to understand the unstructured records to be understandable by the computer. NLP also uses some special engines to find previous records of the patient. The main advantage of NLP is it can scan and organise a large number of chart records of the patients into some important needs in the clinical reports. It is a very difficult process if it is treated manually by the hospital staff and identified per individual patient's personal information. The output of NLP and then EHR structured data is undergone through statistical analysis to identify the complications and the severity of COVID-19 patients. The risk factors associated with it help us to avoid the poor outcomes of the patients.

The data or the clinical prescription in unstructured format is taken and given as an input for the natural language processing. The available data is broken into paragraphs, words, and sentences. It helps identify and analyse the order of words in lexical analysis which is the first step in natural language processing. In syntactic analysis, it observes the words and the relation between them. It accepts only those sentences which are meaningful or else the analyser rejects it. This stage is also called parsing. In syntactic analysis, it uses two methods; they are context-free grammar and top-down parser. The semantic analysis checks for the meanings in the dictionary and checks for the meaningfulness and is rejected if it is not meaningful. It also checks the sentence, which is the succeeding sentence. The actual sentences are reinterpreted to know the real-world knowledge present in the database to derive the language's aspects. Finally, output data is obtained. NLP is also used in treating heart diseases and wound detections [14] (Fig. 13.7).

Fig. 13.7 Natural language processing

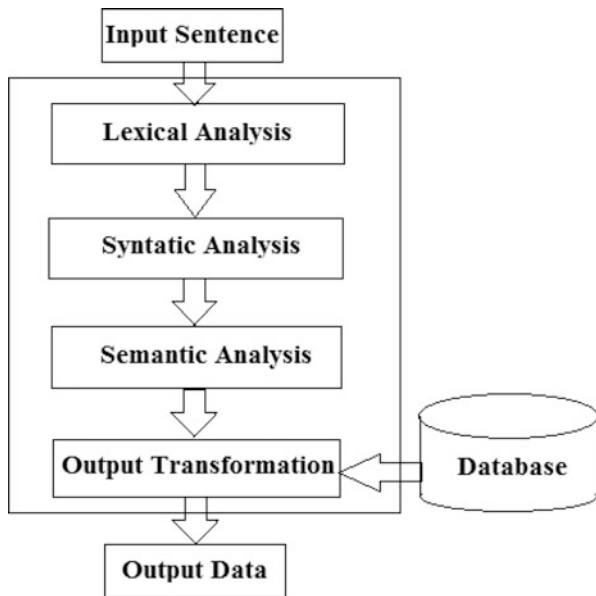

13.3 COVID-19

13.3.1 COVID-19 Clinical Records

Nowadays the world is suffering from the most dangerous virus which is named as COVID-19. The main risk factors of this disease are age factors and the underlying diseases of the patients. Many researchers are going on to treat the disease. However, apart from its diagnosis and vaccine trials, it is spreading widely within a few months. The main drawback or the time-consuming process takes place in identifying the disease. Since due to non availability of vaccine or medicine to cure this disease, we can only get rid of this disease to take the precautions to get rid of this disease or to diagnose in early stages once it is affected. Pneumonia is not treated seriously in the early stages, the main parts affected are the lungs and heart followed by the kidney and liver [15]. According to Xun Li’s survey, they collected the clinical records of 25 patients died of COVID-19 the maximum patients who died are hypertension, diabetes and age are the maximum risk factors [15]. Some of the clinical records of the victims of COVID-19 are collected from the ICMR issued by the government district hospital, Anakapalle, Visakhapatnam. We have collected 25 clinical samples of patients like clinical records and their chest X-rays or computed tomography. Among the 25 patients, 10 were male, and 15 were female (Table 13.1).

For all those 25 patients, the symptoms started gradually and lasted within 2 weeks. Among those, only 10 patients have fever and cough, and the remaining has not experienced this. Only 5 patients have observed runny nose, sore throat, body

Table 13.1 Symptoms cycle and symptoms of 25 patients

Symptoms cycle	COVID-19	No. of patients
Time-lapse between virus catching and showing its symptoms	2–14 days	All
Symptoms starting	Gradual	All
Symptoms lasting	Minor cases: 2 weeks Severe: 3–6 weeks	All
<i>Symptoms</i>		
Fever	Common	10
Runny nose	Less common	5
Sore throat	Less common	5
Cough	Common	10
Body ache	Less common	5
Breathing difficulty	Less common	0
Chest pain	Less common	0
Loss of taste or smell	Less common	2
Diarrhoea	Less common	5
Tiredness	Less common	5
Headache	Less common	5

ache, tiredness, and headache. Only 2 people lost the sense of smell and taste. So, in our survey, the maximum symptoms which were observed are fever and cough. None of them was having severe symptoms among those 25 patients. A maximum people were of middle age, and 1 people died due to underlying disease (diabetes) at age 55. So, based on the majority of symptoms, we can say that people who experienced fever and cough are the main victims of COVID-19. The patients who been have recognised early are diagnosed early. Maximum risks are prone to people who have recognised the disease with serious symptoms. So, symptoms identified in the early stages have also helped the lives of many people or other adverse effects. Patients' maximum clinical records required less treatment as they were in early stages in diagnosing the disease; there were no complications held in treatment. Most of the patients were discharged within 2 weeks who have experienced fewer symptoms; they were discharged. Artificial Intelligence Techniques can apply these clinical records Approaches like Natural Language Processing Techniques to get better effective outcomes. Clinical records are meant to be the patient's prescription, and chest X-rays also help identify the disease severity levels. The external factors can be represented only through the behaviour of the patient's symptoms, but the right judgement can be made only by observing the internal factors like chest X-rays, also known as computed tomography. Chest X-ray of the patient with mild symptoms is taken and compared with the patient who is a severe victim (Fig. 13.8).

Chest X-rays' images are manually identified to spot out the difference between the healthy normal person and victim of COVID-19 patient. Still, it is difficult to find out manually as there are slight changes that can only be identified by the professional radiologists, which is a bit time-consuming process and a cost-effective

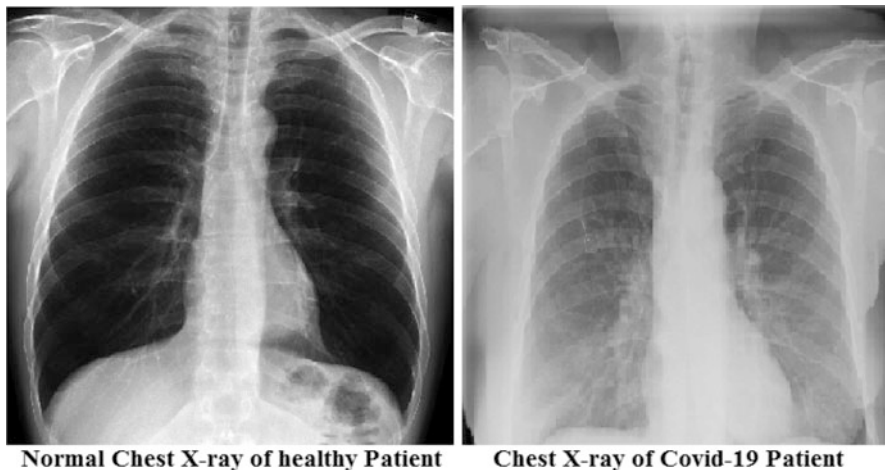

Fig. 13.8 Chest X-ray images of normal and COVID-19 patients

process that required resources. Artificial intelligence approaches like artificial neural networks help identify the victims' chest radiology, which is low cost and provides fast outcomes. In most of the places, people are not concentrating on taking the radiology by assuming to having mild symptoms as there were less professional available in some places to identify this radiology. The actual risk factors and severity of the disease can be identified through this radiology. As COVID-19 is a respiratory tract infection, it has significant effects first on the respiratory system.

So, it can only be observed through chest radiology. Apart from the clinical reports and the COVID-19 victims' records, these chest radiographs also play an essential role in researching the severity risks of COVID-19 [16]. These clinical records and these radiographs require a lot of time when we assume manually, and manual work may also have errors and false predictions, which may sometimes result in worse outcomes. In this modern world, using modern technology like artificial intelligence helps identify the exact outcomes with effective results and less time consumption. There are many techniques associated with artificial intelligence that anyone can use, which is relevant to our problem.

13.3.2 Artificial Intelligence Approaches for COVID-19

There are several techniques present in artificial intelligence topics to deal with healthcare systems. Mainly artificial neural networks and natural language processing play an essential role in identifying many diseases. These techniques have proven their results from past years. The convolution neural network, which is the

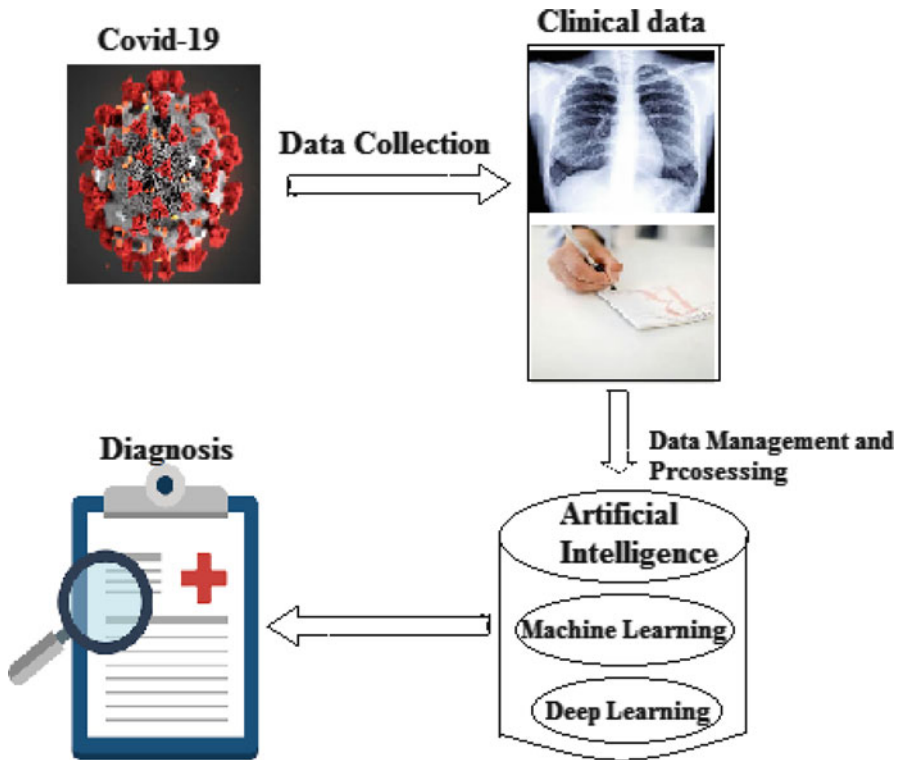

Fig. 13.9 Artificial intelligence approaches to COVID-19

artificial neural networks method, has proven its effective image recognition and analysis results (Fig. 13.9).

As the number of death and the spread rate of COVID-19 increases day by day, it is a serious topic to diagnose the victims from this virus. Artificial intelligence, machine learning, and deep learning have proven its advantages in medical diagnosis. These techniques also help in a few ways to recognise the disease earlier and to diagnose. Firstly, we are gathering the data regarding COVID-19 and the patients' health condition we are going to analyse and diagnose. Gathering of data includes large amounts of data like the physical prescription of the patient's data written by the physicians. The data is maintained in the form of electronic health record (EHR) systems. Clinical records for COVID-19 can also include chest radiographs which help a lot in examining the diseases. These clinical records are meant for data management and processing. We can apply many artificial intelligence techniques like artificial neural networks and some deep learning techniques like natural language processing techniques. By giving the clinical data as input to these techniques and based on the outcomes, we can diagnose the patients based on the patients' actual condition. If all these are done in manual, it requires a

lot of time consumption to process the data, and the prediction analysis can be false sometimes and inadequate. Artificial Intelligence technique provides the best results with accurate results and less time consuming, which is one of the best advantages that let the world use it from last past years.

13.3.2.1 Artificial Neural Networks for COVID-19

Artificial neural networks comprise of many methods like multilayer perception (MLP), radial basis function network (RBFN), and convolution neural network (CNN). Convolution Neural Network is one of the best ANN methods that have proved its efficiency in dealing with image analysis and recognition. Convolution neural networks have already proved its results in generating the best results in identifying COVID-19 [13]. Firstly the medical images of COVID-19 victims have been taken and applied to convolution neural networks. CNN is based on convolution, nonlinearity, pooling, and classification process. The input image which we need to find out has been given to the network. We have trained the dataset by adding all the clinical chest radiology of all the patients and mentioned the images' values based upon the dissimilarities present in the images. Based on the datasets, the input images go through featured maps and pooled feature maps and finally generate an outcome, showing whether the image belongs to which disease is based upon the values. After creating the datasets, we need to train the datasets based upon some criteria. Synthesis of Dataset were done manually containing the patients' ID, patients' records, and patients' radiology (Fig. 13.10).

CNN uses the most powerful networks like VGG, ResNet, DenseNet, Inception, and Xception. Xception is one of the best convolution neural networks which has added more number of inception layers. It uses depth-wise convolution layers and also point-wise convolution layers. ResNet50V2 is the better version of ResNet50. ResNet50V2 and Xception have achieved better results in ImageNet dataset [17].

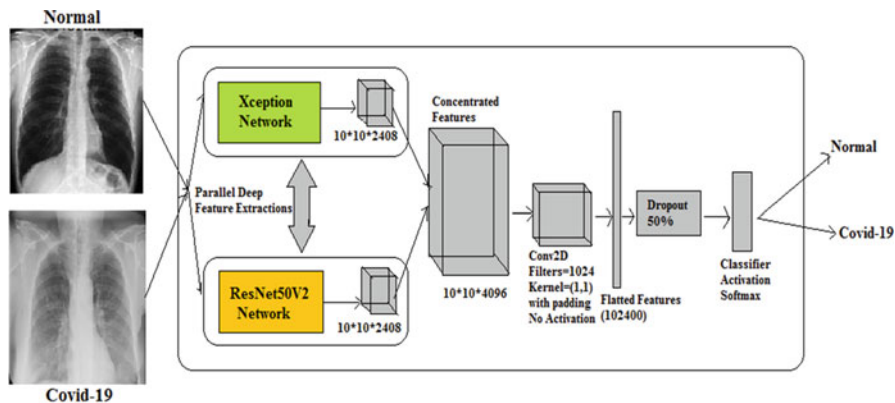

Fig. 13.10 Artificial neural network approach to COVID-19 chest radiography

To create a dataset, it involves some step-by-step procedures. Firstly we need to gather the data of COVID-19 patients, and we need to handle the missing values if they are present. The next step is to take the data for the feature extraction process. We need to decide the key factors in creating the dataset, which is important with regard to creating the dataset—based upon the gathered data, we need to classify the data into a training set and testing set. Here we have taken 25 sample clinical records of the patients based upon the records, and we need to classify them into training sets and testing sets. Training dataset is assigned by assigning some values, and later on, we need to compare them with testing values.

We have taken the image of 300×300 pixels. Based on the input image, Xception generates $10 \times 10 \times 2048$ feature map on its last feature. ResNet50V2 also produces the same feature map on its final layer. As these networks both produced the same feature maps, they both use inception-based layers and residual-based layers. The quality of semantic features is enhanced. The features are connected to a convolution layer, and later they are connected to the classifier. The feature's kernel size was added when 1×1 with 1024 filters and no activation function. Each channel is a feature map, and it acts as a spatial point between all the channels.

13.3.2.2 Natural Language Processing for COVID-19

NLP is also one of the best AI techniques used in healthcare systems. It has proven its results in many multitude companies like text recognition and image recognition. NLP Technique work by taking image as an input and performing lexical analysis, syntactic analysis, semantic analysis, and output transformation and finally providing its output. Here in treating COVID-19, we will take the medical prescription of the COVID-19 patient and give the image of this clinical record as an input to the NLP technique. Next, the preprocessing stage is where the classification and detection of paragraphs in the prescription take place. Here section detection, sentence detection, and ambiguity are reduced, which is presented in the sentences. The total image has been divided into the parts to identify the key terms present in medical technology. By identifying the terms in the prescription, it is discovered that the patient has a fever but no cough. It starts in detecting problems using mind map transfer technique, which makes notes based on the colours, patterns, keywords, and images. This helps identify the total paragraph based on the medical keywords, and we can identify the medical terminology in human language, which helps identify the disease. Negation detection is the process where it is based on the rule which is very effectively used in many NLP systems. For example, if we consider the NegEx process by finding negation and termination terms, it is sometimes used for termination [18] (Fig. 13.11).

The total image has been divided into parts based on the keywords and the medical terms. Codes have been given on the database based on the symptoms. Ambiguity has been removed, which made disturbances in identifying the disease. During the post-processing process, the ambiguity issues have been resolved and

Fig. 13.11 Natural language processing approach for COVID-19

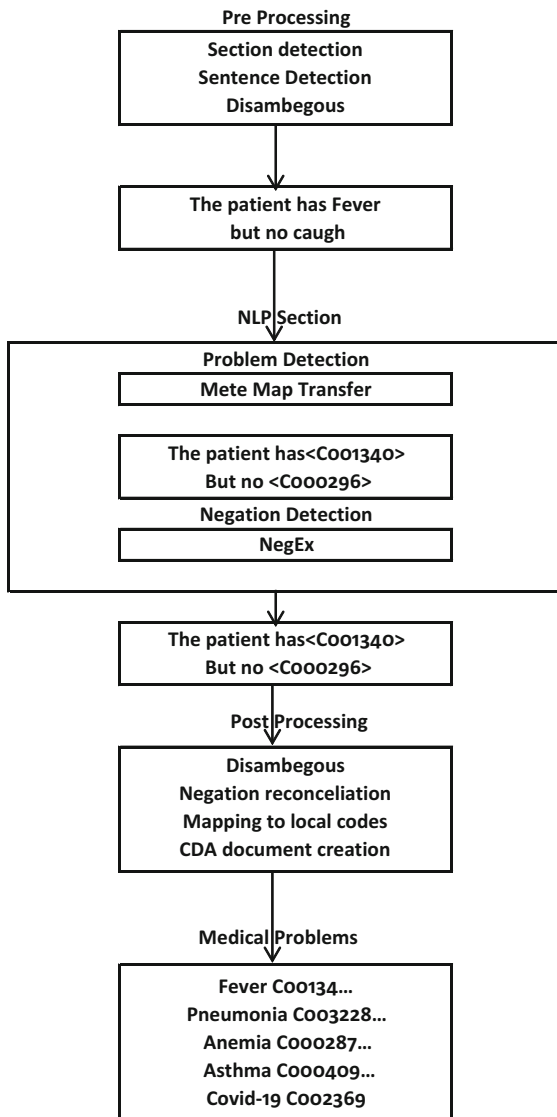

maintain compatibility with other sentences. The mapping process is done based on the codes of the medical terminology terms and processing. Finally, clinical data analysis (CDA) has been created based on the analysis based on the processing techniques. Finally, an electronic report of the prescription of the COVID-19 patient has been obtained as an outcome. When we applied patient records to NLP, one patient’s symptoms are different from another, and it differs from person to person. Still, in maximum cases of patients, the main symptom they have experienced is fever.

13.4 Conclusion

Based on the research, artificial intelligence approaches like artificial neural networks and natural language processing techniques have generated its efficient results in finding the symptoms and the severeness of COVID-19 patients. Compared with the prescription analysis of chest X-ray images, it has provided accurate and efficient analysis in finding the severity of the disease and its risks. These techniques reduce time consumption and provide accurate data electronically compared with the manual data, which is difficult to process manually. These findings help the victims diagnose early and reduce the death risks that help the patients recover early.

References

1. S.J. Fong, N. Dey, J. Chaki, An introduction to COVID-19, in *Artificial Intelligence for Corona Virus Outbreak*, Springer Briefs in Applied Sciences and Technology, (Springer, Singapore, 2022). https://doi.org/10.1007/978-981-15-5936-5_1
2. Chinese citizens push to abolish wildlife trade as corona virus persists, <https://www.nationalgeographic.com/animals/2020/01/china-bans-wildlife-trade-after-corona-virus-outbreak/>
3. D. Cucinotta, M. Vanelli, WHO declares COVID-19 a pandemic. *Acta Bio medica Atenei Parmensis* **91**(1), 157–160 (2020). <https://doi.org/10.23750/abm.v91i1.9397>
4. D.D. Luxton, Chapter 1 - An introduction to artificial intelligence in behavioral and mental health care, in *Artificial Intelligence in Behavioral and Mental HealthCare*, ed. by D. D. Luxton, (Academic Press, Cambridge, 2016), pp. 1–26. <https://doi.org/10.1016/B9780124202481.000015>. ISBN 9780124202481. <http://www.sciencedirect.com/science/article/pii/B9780124202481000015>
5. D. Douglas Miller, E.W. Brown, Artificial intelligence in medical practice: The question to the answer? *Am. J. Med.* **131**(2), 129–133 (2018). <https://doi.org/10.1016/j.amjmed.2017.10.03>. ISSN 00029343. <http://www.sciencedirect.com/science/article/pii/S0002934317311178>
6. M.P. Amisha, M. Pathania, V.K. Rathaur, Overview of artificial intelligence in medicine. *J. Family Med. Prim. Care* **8**(7), 2328–2331 (2019). https://doi.org/10.4103/jfmpc.jfmpc_440_19
7. K. Kristian, Machine learning and artificial intelligence: Two fellow travelers on the quest for intelligent behavior in machines. *Front. Big Data* **1** (2018). <https://doi.org/10.3389/fdata.2018.00006>. ISSN 2624-909X. <https://www.frontiersin.org/article/10.3389/fdata.2018.00006>
8. S.L. Goldenberg, G. Nir, S.E. Salcudean, A new era: Artificial intelligence and machine learning in prostate cancer. *Nat. Rev. Urol.* **16**, 391–403 (2019). <https://doi.org/10.1038/s41585-019-0193-3>
9. S.H. Chen, A.J. Jakeman, J.P. Norton, Artificial intelligence techniques: An introduction to their use for modelling environmental systems. *Math. Comput. Simul.* **78**(2–3), 379–400 (2008). <https://doi.org/10.1016/j.matcom.2008.01.028>. ISSN 0378-4754. <http://www.sciencedirect.com/science/article/pii/S0378475408000505>
10. A.J. Schaefer, M.D. Bailey, S.M. Shechter, M.S. Roberts, Modeling medical treatment using Markov decision processes, in *Operations Research and Health Care*, International Series in Operations Research & Management Science, ed. by M. L. Brandeau, F. Sainfort, W. P. Pierskalla, vol. 70, (Springer, Boston, MA, 2005). https://doi.org/10.1007/1-4020-8066-2_23

11. M. Chary, S. Parikh, A.F. Manini, E.W. Boyer, M. Radeos, A review of natural language processing in medical education. *West. J. Emerg. Med.* **20**(1), 78–86 (2019). <https://doi.org/10.5811/westjem.2018.11.39725>
12. R. Yamashita, M. Nishio, R. Do, K. Togluenashi, Convolutional neural networks: An overview and application in radiology. *Insights Imag.* **9**(4), 611–629 (2018). <https://doi.org/10.1007/s13244-018-0639-9>
13. S.S. Yadav, S.M. Jadhav, Deep convolutional neural network based medical image classification for disease diagnosis. *J. Big Data* (2019). <https://doi.org/10.1186/s40537-019-0276-2>
14. M. Topaz, K. Lai, D. Dowding, V.J. Lei, A. Zisberg, K.H. Bowles, L. Zhou, Automated identification of wound information in clinical notes of patients with heart diseases: Developing and validating a natural language processing application. *Int. J. Nurs. Stud.* **64**, 25–31 (2016). <https://doi.org/10.1016/j.ijnurstu.2016.09.013>. ISSN 0020-7489. <http://www.sciencedirect.com/science/article/pii/S0020748916301602>
15. X. Li et al., Clinical characteristics of 25 death cases with COVID-19: A retrospective review of medical records in a single medical center, Wuhan, China. *Int. J. Infect. Dis* **94**, 128–132 (2020). <https://doi.org/10.1016/j.ijid.2020.03.053>
16. A. Jacobi, M. Chung, A. Bernheim, C. Eber, Portable chest X-ray in coronavirus disease-19 (COVID-19): A pictorial review. *Clin. Imag.* **64**, 35–42 (2020). <https://doi.org/10.1016/j.clinimag.2020.04.001>
17. M. Luengo-Oroz, K. Hoffmann Pham, J. Bullock, et al., Artificial intelligence cooperation to support the global response to COVID-19. *Nat. Mach. Intell.* **2**, 295–297 (2020). <https://doi.org/10.1038/s42256-020-0184-3>
18. S. Meystre, P.J. Haug, Natural language processing to extract medical problems from electronic clinical documents: Performance evaluation. *J. Biomed. Informatics* **39**(6), 589–599 (2006). <https://doi.org/10.1016/j.jbi.2005.11.004>. ISSN 1532-0464. <http://www.sciencedirect.com/science/article/pii/S1532046405001140>